



Cliente: e2tech.lda  
 Url: www.xlparty.com

Ferramentas:  
 

**XLPARTY**

Login / Register

Pesquisar...

Parceiro Institucional: santa maria da feira câmara municipal

Parceiro Tecnológico: hp, ZON

ISP Oficial

HOME | XLPARTY | OUTROS EVENTOS | ENSCRIÇÕES | CONTACTOS | FORUNS | GALERIAS | VÍDEOS | DOWNLOADS | MEDIA

Home > Cascais 08

Evento | Local | Passatempos | Plano do Evento | Regulamento

### XLPARTY Cascais 08 de 19 a 21 de Dezembro CASCAIS 2008

**Confirmações Pré-Pagamento**  
 Confirmações Pré-Pagamento Informamos todos os que querem participar na XLPARTY que a opção Pré-Pagamento, se encontra indisponível a partir da meia-noite de hoje (10-12-2008). Os participantes que efectuaram o pré-pagamento terão os seus dados atualizados até às 24:00 de 6ª feira...

**Informação Importante.**  
 Boas pessoal, Queremos informar todos os participantes que as inscrições online já são superiores à capacidade do recinto. Informamos ainda que reservamos lugar a todos aqueles que efectuarem o pré-pagamento. Todos aqueles que apenas fizeram a inscrição online e pretendem fazer o pagamento ...

**Prendas e prémios XLPARTY.**  
 Mais uma vez o Pai Natal vai chegar mais cedo para os grandes vencedores do evento XLPARTY. Criámos mais torneios e passatempos para que todos tenham oportunidade de levar um presente para casa. Podes Consultar os Passatempos XLPARTY através deste link. Podes Consultar todos os torneios e res...

**Torneios XLPARTY Cascais 2008**  
 A menos de um mês da XLPARTY de Natal, a organização dá a conhecer os torneios que vão estar presentes na última feira de 2008: Torneios PC WGT: Counter Strike Source (3vs3) FIFA 09 (2vs2) Trackmania Nations Forever (1vs1) PC Counter Strike 1.6 (5vs5) Call of Duty 2 (3vs3) ...

**Modding PC/DIGA na XLPARTY**  
 Mais uma vez o concurso de Modding vais estar presente no evento. E neste natal a XLPARTY e a PC/DIGA (patrocinador do concurso de modding) vão reservar para os mais originais e criativos os seguintes prémios: 1º Prémio - Lian Li 7077b 2º Prémio - Controlador Zalman ZM-MFC2 3º Prémio - Rev...

<< Prev 1 2 3 4 Next >>

**ÚLTIMAS NOTÍCIAS**

- 09.02.03 - Torneios XLPARTY Santa Mar...
- 09.02.03 - Não te esqueças de nada....
- 09.02.03 - XLPARTY Santa Maria da Fei..
- 09.01.19 - Votação Torneios SMF 09
- 09.01.15 - Fotos dos Vencedores Casca..
- 09.01.14 - Europarque
- 08.12.24 - Feliz Natal e um Próspero ...
- 08.12.22 - Vencedores XLPARTY Cascaiz..
- 08.12.22 - Report Final Cascais 2008
- 08.12.21 - XLPARTY SMF 2009
- 08.12.20 - Fotos do evento
- 08.12.20 - Encontra-se a decorer o t..
- 08.12.20 - Os participantes da XLPARTY..

VER MAIS

**VÍDEOS**

- XLPARTY CASCAIS dia 2  
 Visualizações: 1800
- Através-te a descobrir!!!  
 Visualizações: 1729
- XLPARTY PORTO: Report dia 2  
 Visualizações: 4343
- XLPARTY PORTO 08 - Spot publicitário  
 Visualizações: 2846

VER MAIS

**GALERIAS DE FOTOS**

- XLPARTY CASCAIS 08  
 Numero de Fotos: 178

**Patrocinadores**

ASUS  
 Rock Solid · Heart Touching

intel

EA



XBOX 360

vobis

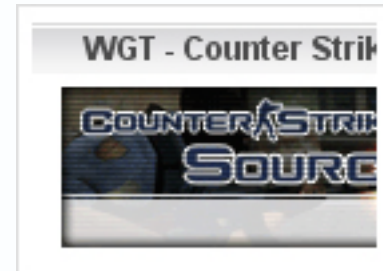
RAZER



Cliente: e2tech.Ida  
 Url: www.xlparty.com

Ferramentas:  

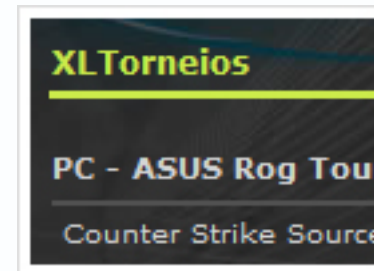
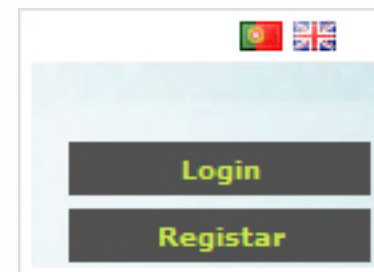

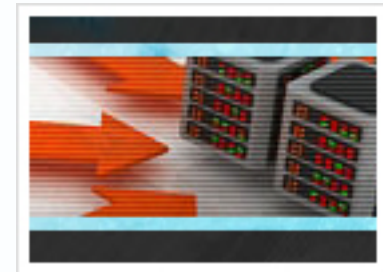

Cliente: e2tech.lda  
 Url: www.xlparty.com

Ferramentas:  
 Fw Ps



Cliente: e2tech.lda  
 Url: www.xlparty.com

Ferramentas:



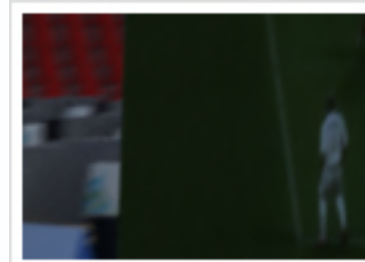
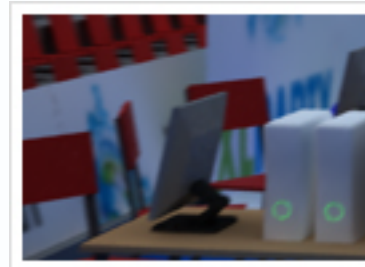
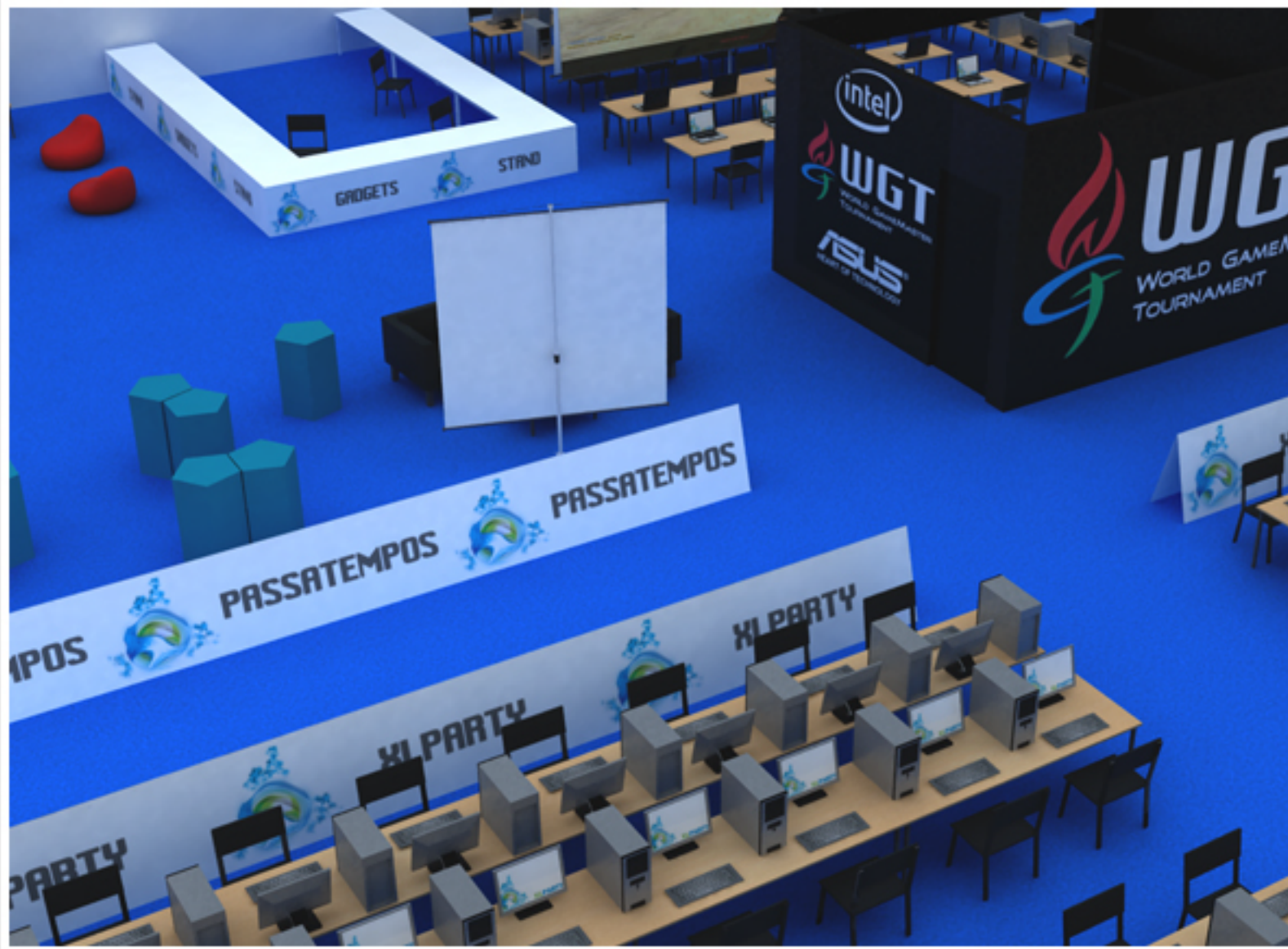

Cliente: e2tech.Ida

Url: [www.youtube.com/xispesmedia](http://www.youtube.com/xispesmedia)

Ferramentas:



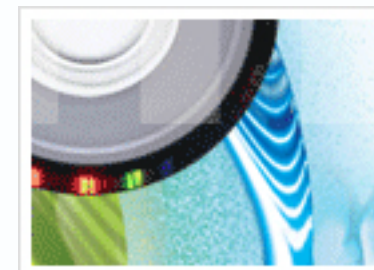
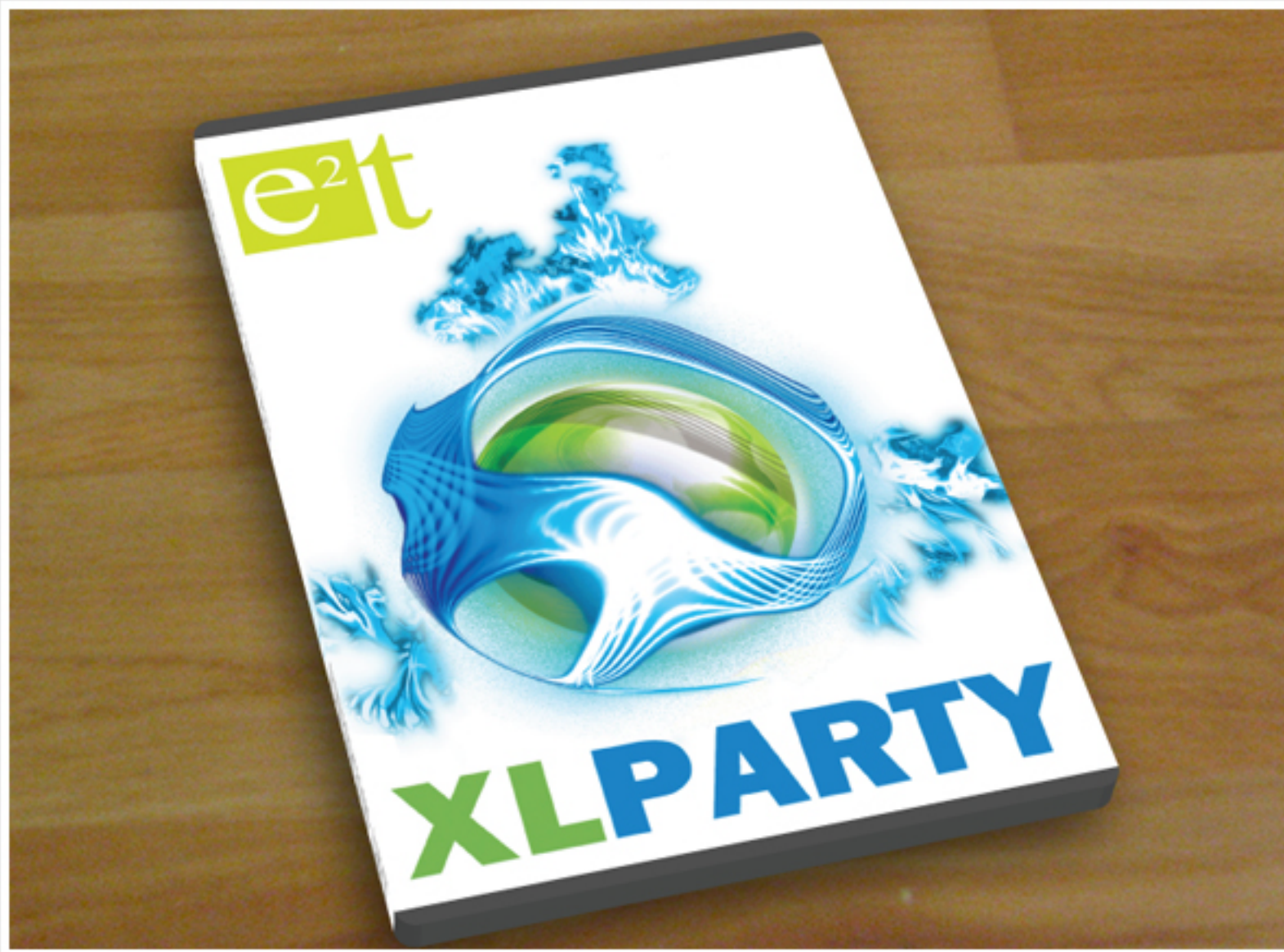

Cliente: e2tech.lda  
Url: [media.xispes.com](http://media.xispes.com)

Ferramentas:



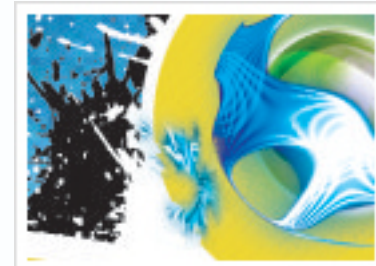

Cliente: e2tech.lda  
Url: media.xispes.com

Ferramentas:



since 1985

# KEBACK

for Identity Products

Lanyard Pin's Gravuras Portachaves Bandas Expositores BT CAP Catálogo

- Home
- Quem Somos
- Produtos
- Condições de Venda
- Contactos

Bem vindo à Keback Portugal

Gostaríamos de dar as boas vindas a todos os visitantes ao nosso web site

**Keback UK Company** é um produto de uma vasta gama de artigos de publicidade. A Keback está no mercado europeu desde o ano de 1985 e possui escritórios de vendas na Europa e Ásia.



História em Portugal.....

A Keback Portugal dedica **a sua venda única e exclusivamente a revendedores**. Somos uma empresa de distribuição e as nossas vendas são efectuadas através de distribuidores e fabricantes, e nunca directamente ao cliente final...



A Keback Portugal dedica a sua oferta em 10 gamas de produtos principais: **Metais, LogoBands, gravatas e lenços, têxteis, cintos, bandeiras e banners, malas e sacos, BT-Bonés e BT-Elastico e por fim a feiras e exposições.**

Para informações adicionais ou questões sobre os nossos produtos e preços não exite em nos contactar. A Keback Portugal terá todo o prazer de o/a ajudar.



© 2007 Keback PT produzido por Xispes-Media

Pin's Gravuras

Ben

Gost

Cliente: Keback Portugal



Url: (para venda)

Ferramentas:

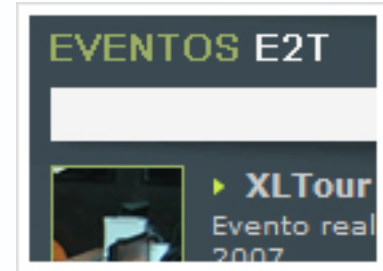
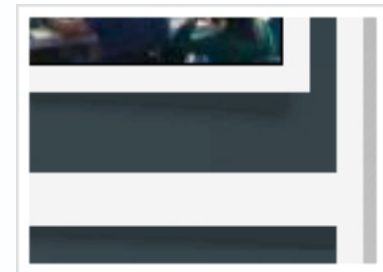
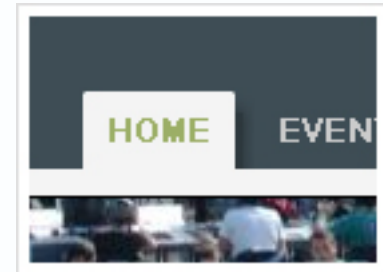
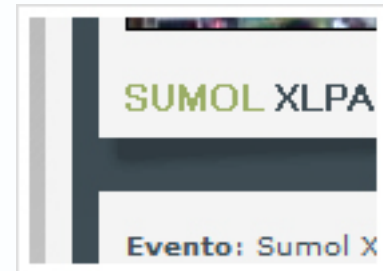



Cliente: e2tech.lda  
 Url: www.e2t.pt

Ferramentas:  
 

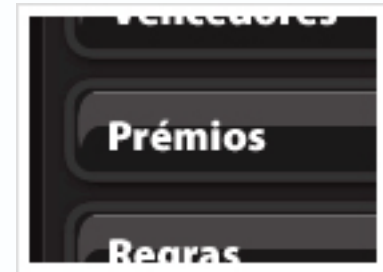
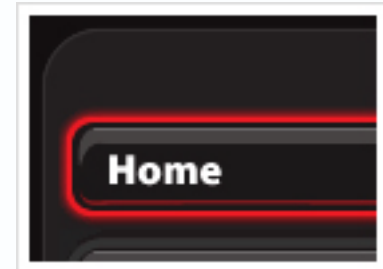

Cliente: e2tech.lda

Url: [www.universitychallenge.net](http://www.universitychallenge.net)

Ferramentas:



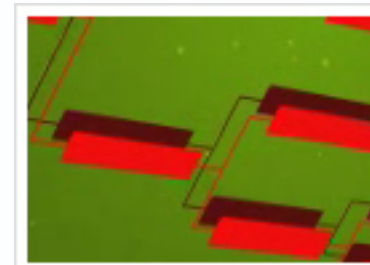
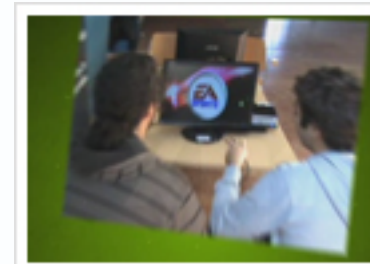
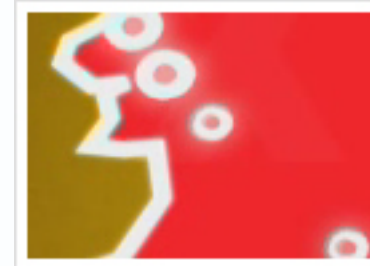

Cliente: e2tech.lda

Url: [www.youtube.com/xispesmedia](http://www.youtube.com/xispesmedia)

Ferramentas:



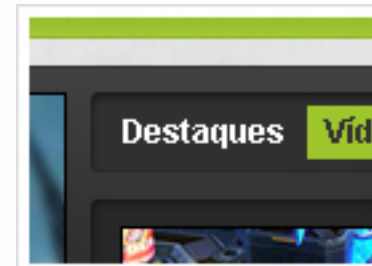
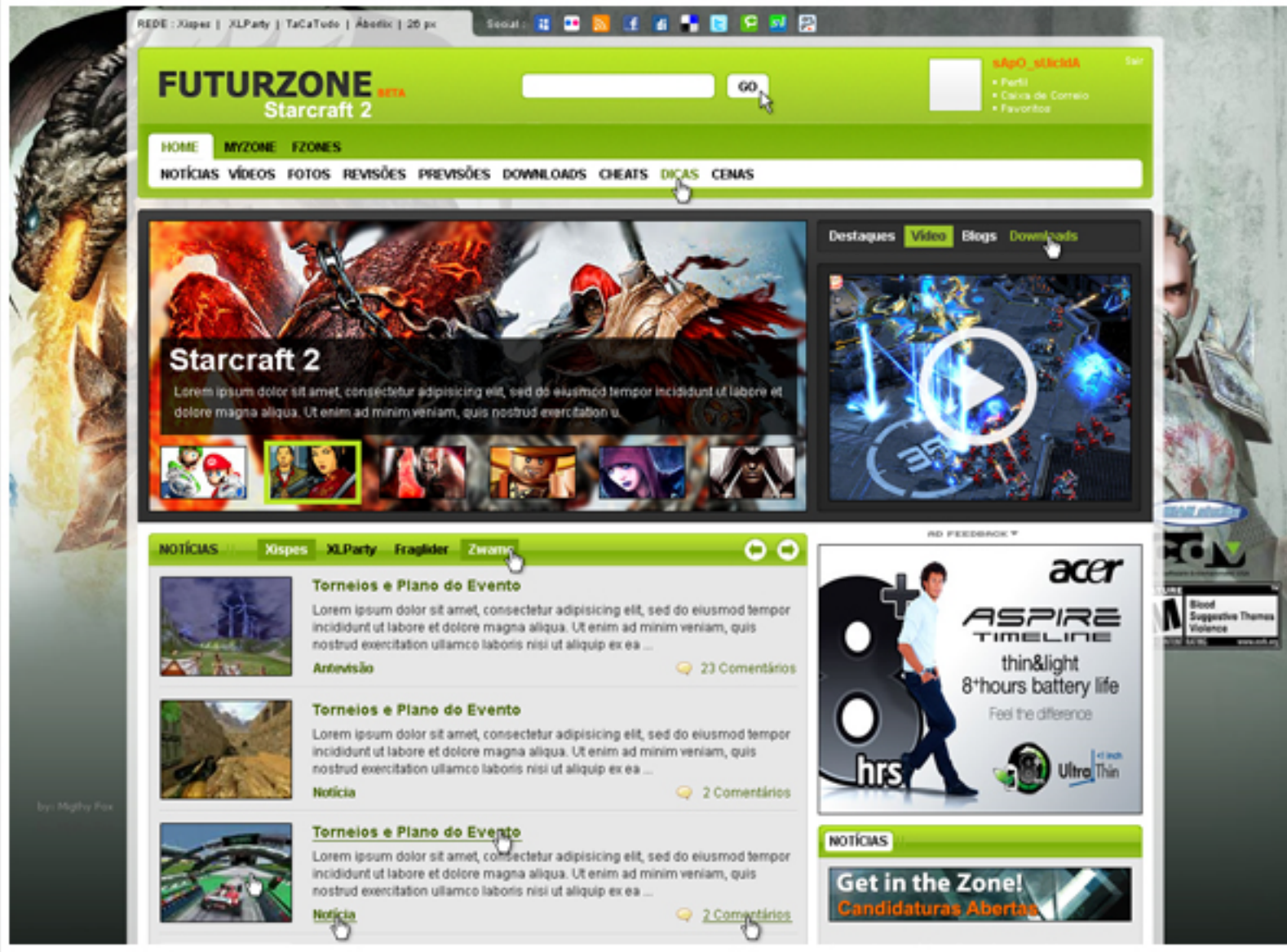

Cliente: Xispes-Media  
 Url: www.futurzone.com

Ferramentas:



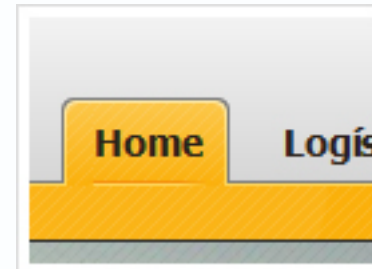
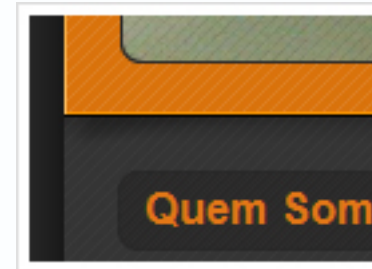
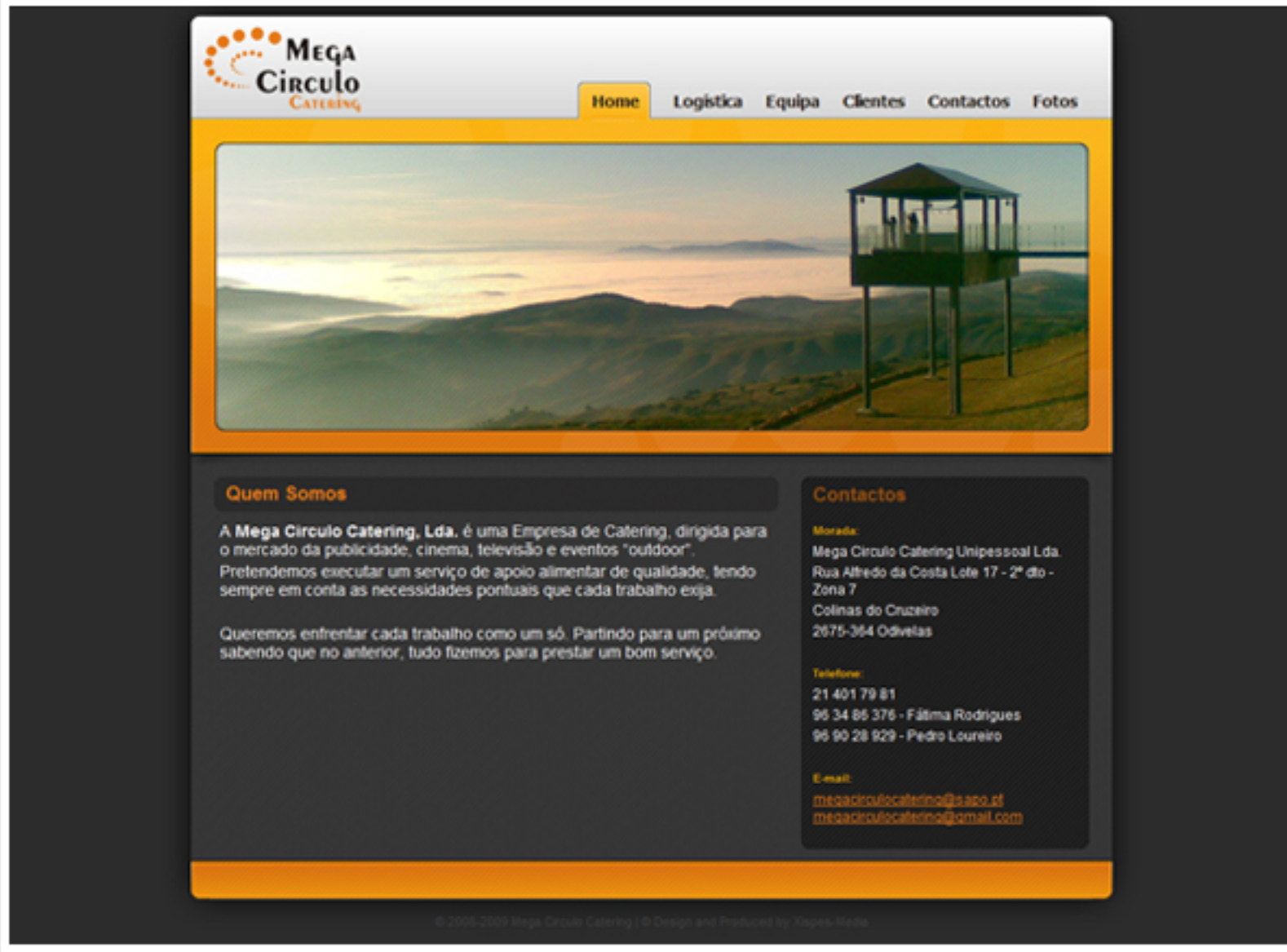

Cliente: Mega Circulo Catering  
 Url: [www.megacirculocatering.pt](http://www.megacirculocatering.pt)

Ferramentas:



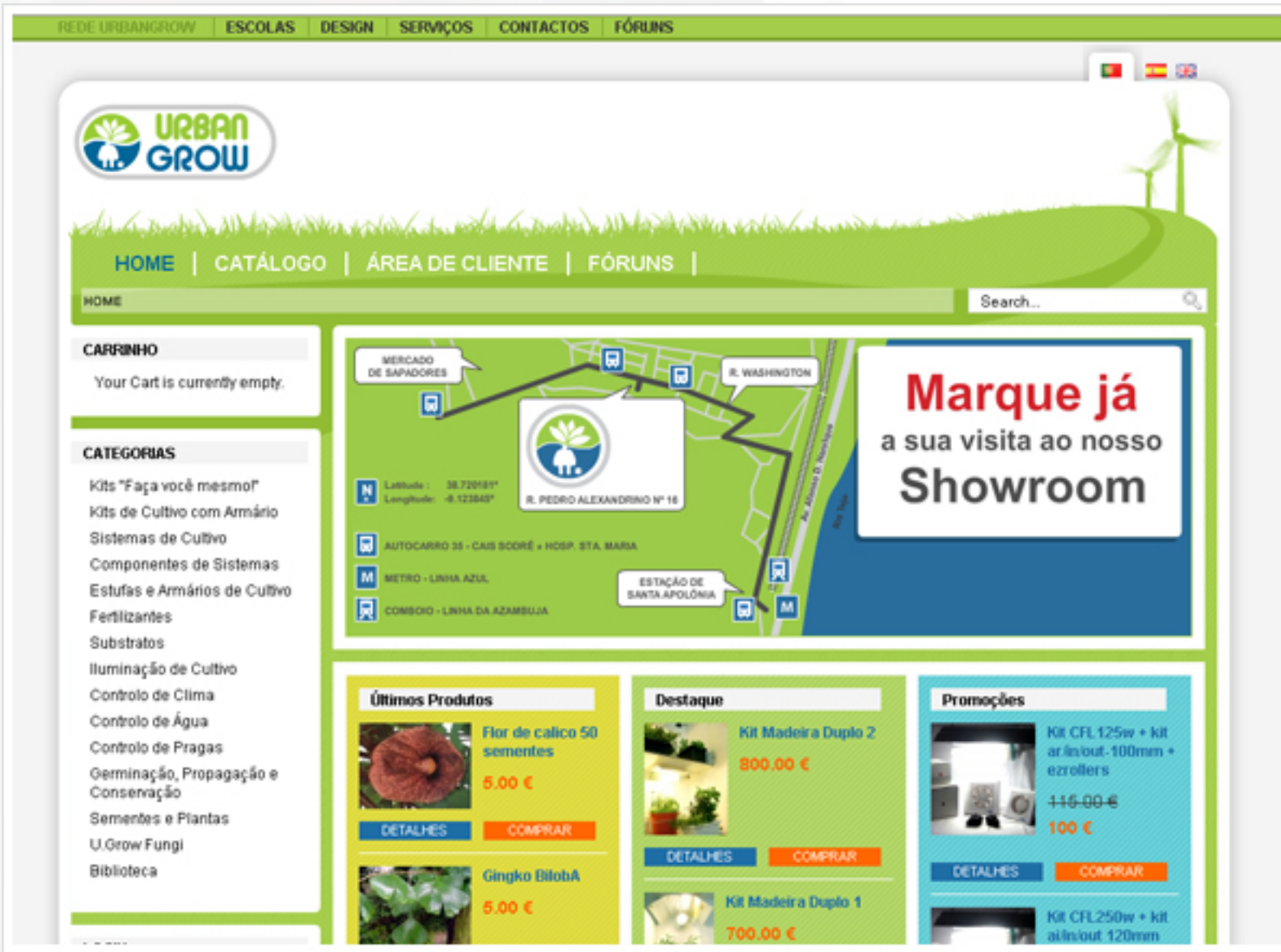

Cliente: UrbanGrow - Agricultura e Design

Url: offline

Ferramentas:



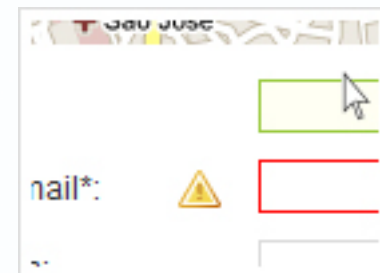
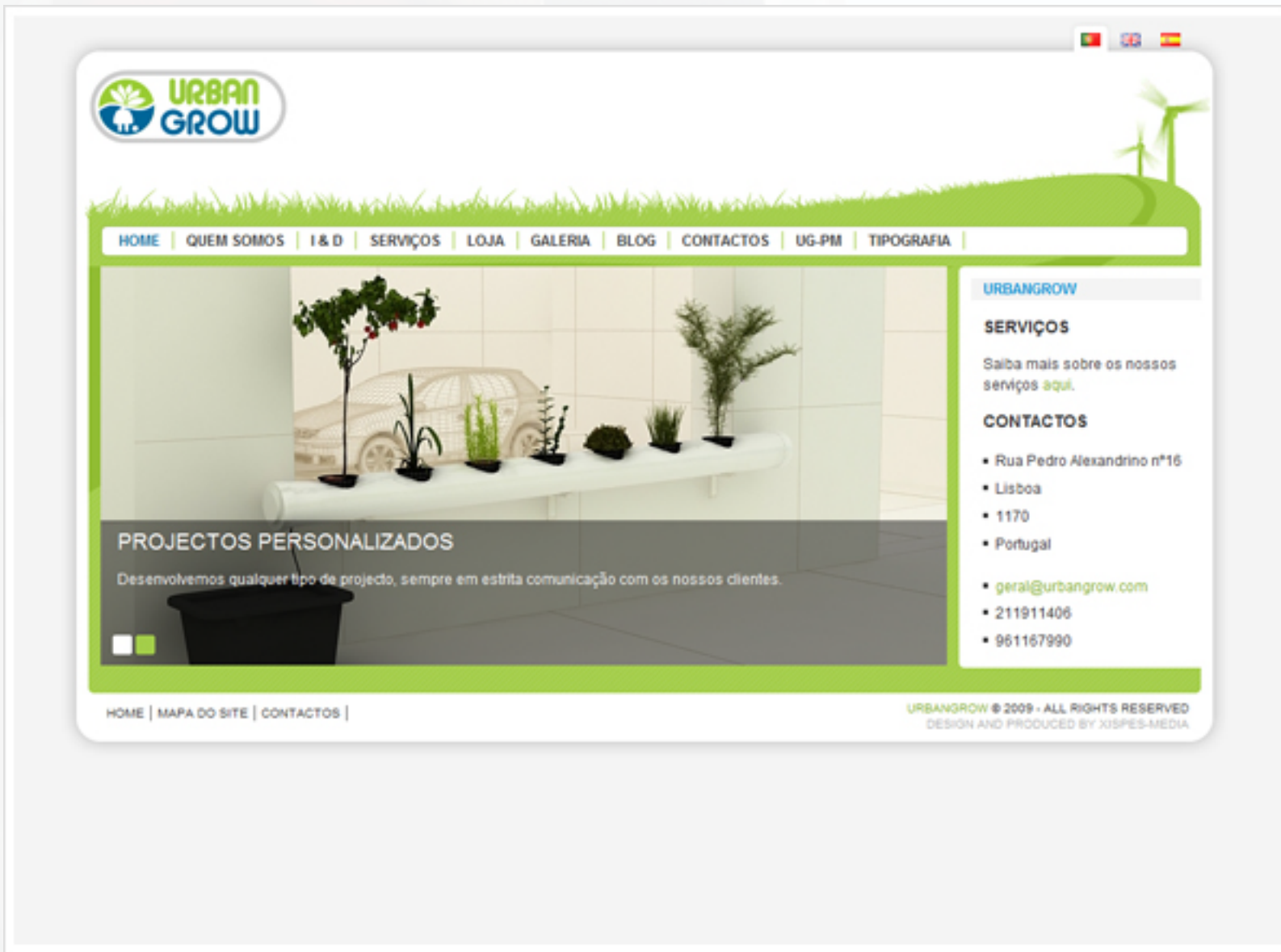

Cliente: UrbanGrow - Agricultura e Design  
 Url: www.urbangrow.com

Ferramentas:



The screenshot shows the UrbanGrow website interface. At the top left is the logo with a stylized plant and the text 'URBAN GROW'. Below the logo is a navigation menu with links: HOME, QUEM SOMOS, I & D, SERVIÇOS, LOJA, GALERIA, BLOG, CONTACTOS. A breadcrumb trail reads 'Home > Loja > Sistemas de Cultivo > Hidroponia'. On the left side, there is a 'CART' section stating 'O seu carrinho de compras encontra-se de momento vazio.' and a 'CATEGORIAS' section with a list of categories including 'SISTEMAS DE CULTIVO', 'TERRA', 'HIDROPONIA', 'AERO-HIDROPONIA', 'AEROPONIA 100%', 'HORTAS E JARDINS VERTICAIS', 'REBENTOS E MICROVERDURAS', 'GERMINAÇÃO E PROPAGAÇÃO', 'SECAGEM E CONSERVAÇÃO', 'COMPONENTES DE SISTEMAS', 'CULTIVO DE INTERIOR', and 'FERTILIZANTES E'. The main content area is titled 'HIDROPONIA' and shows a list of products. The first product is 'APOLLO 1' (SCH0001) priced at 390,00 €, with a quantity of 1 and an 'ENCOMENDAR' button. The second is 'APOLLO 2' (SCH0002) priced at 990,00 €, and the third is 'APOLLO 3' (SCH0003) priced at 1.369,00 €. Each product has a small image and a 'n/d [Detalhe do Produto...]' link. On the right side, there is a 'LOGIN' section with fields for 'Username' and 'Password', a 'Lembre-me' checkbox, and a 'LOGIN' button. Below that is an 'URBANGROW' section with links for 'Como Comprar', 'Privacidade', 'Condições de Utilização', 'Expedição e Devoluções', and 'Tabela de Portes'. At the bottom right of the main area is a 'CONTACTOS' section with the address: 'Rua Pedro Alexandrino nº16, Lisboa, 1170'. There are also flags for Portugal and the UK in the top right corner.

This block shows a product detail for 'KCA00004'. It features a small image of a plant in a container. To the right of the image, the product ID 'KCA00004' is displayed, followed by the price '400,00'. Below the price are two buttons: an orange 'ENCOMENDAR' button and a green 'MAIS...' button.

This block is titled 'PRODUTOS COM' and features a sub-section for 'Kit Completo M'. It includes a vertical green bar on the left side.

This block is titled 'TERMINAR ENCO' and features a shopping cart icon with a green arrow pointing down into it. It includes a vertical green bar on the left side.

This block is titled 'Info: A quantidade' and features two buttons: a grey 'CONTINUAR' button and a partially visible 'E' button. It includes a vertical green bar on the left side.

Cliente: UrbanGrow - Agricultura e Design  
 Url: www.urbangrow.com

Ferramentas:





Cliente: UrbanGrow - Agricultura e Design

Url: offline

Ferramentas:





Cliente: UrbanGrow - Agricultura e Design  
Url: [www.youtube.com/xispesmedia](http://www.youtube.com/xispesmedia)

Ferramentas:





UL : C=93 M=58 Y=18 K=2	
RDE : C=45 M=0 Y=100 K=0	
UL-CINZA : K=60%	
NTORNO: K=23%	
RDE-CINZA : K=20%	
BRANCO: K=0%	

Cliente: UrbanGrow - Agricultura e Design

Url: offline

Ferramentas:



# CARTÃO DE VISITA URBANGROW



Cliente: UrbanGrow - Agricultura e Design  
Exemplares: 1000

Ferramentas:





Cliente: UrbanGrow - Agricultura e Design  
Exemplares: 1000

Ferramentas:  
Ai



Cliente: UrbanGrow - Agricultura e Design  
Exemplares: 100

Ferramentas:



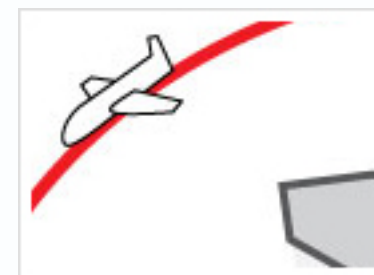
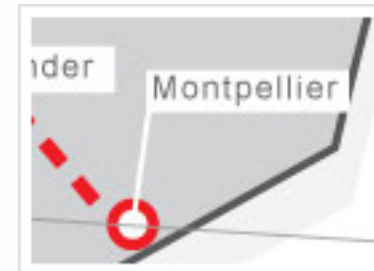

Cliente: Edgar Guerreiro  
Exemplares: 200

Ferramentas:





Cliente: Oficina do Design

Ferramentas:



ESQUINA 16

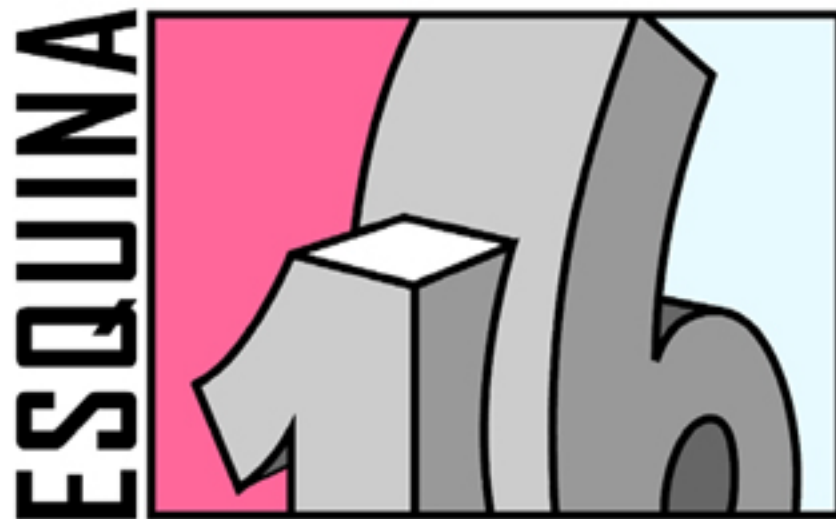

Cliente: Oficina do Design

Ferramentas:

Ai



XI11

XISPES-MEDIA



XI11

XISPES-MEDIA

Cliente: Xispes-Media  
Url: [media.xispes.com](http://media.xispes.com)

Ferramentas:



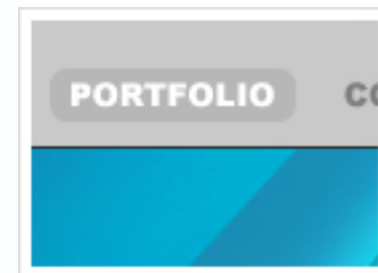
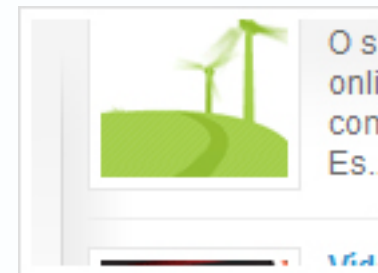
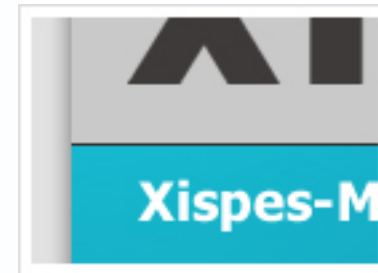
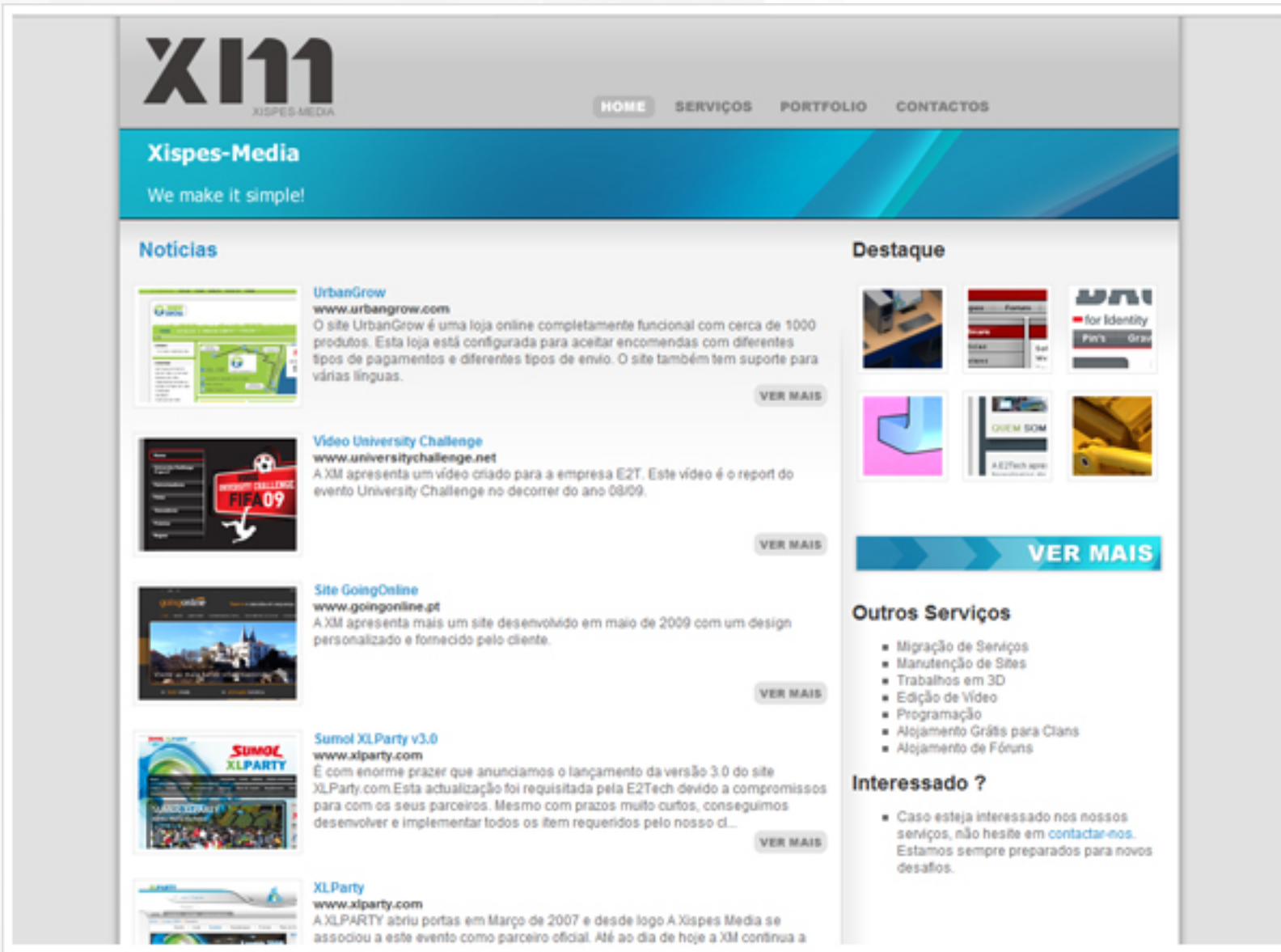

Cliente: Xispes-Media  
 Url: [media.xispes.com](http://media.xispes.com)

Ferramentas:



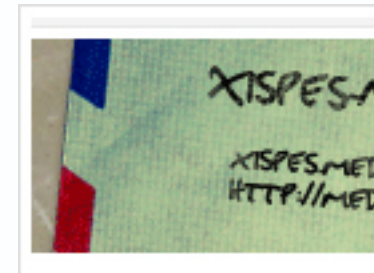
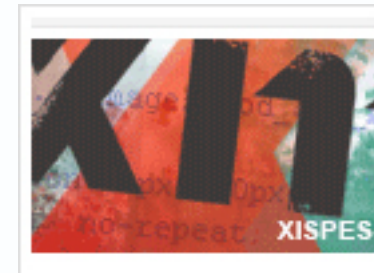

X111  
XISPES-MEDIA
HOME   SERVIÇOS   PORTFOLIO   CONTACTOS



**Xispes-Media**  
We make it simple!

**Bulldozer**  
Modelação 3D - Sábado, 12 Abril 2008 05:34



Este foi um trabalho educativo que foi realizado no decorrer de uma cadeira universitária que tinha como objectivo a demonstração de conhecimentos ao nível de modelação avançada em sistemas de C.A.D., a criação de sistemas complexos de assembly's e a criação de renders finais avançados. As ferramentas de C.A.D. utilizadas foram o **SolidWorks** da **Dassault Systemes S.A.** para a modelação e assembly's, **3ds Max Studio** da **Autodesk** para os renders finais.

Um das características deste projecto foi ter por base um modelo à escala de um Bulldozer, para que desta forma o projecto tivesse o máximo de realismo na construção e que os resultados finais fossem os melhores possíveis. Outro aspecto interessante foi o facto de que todo o veículo funciona no espaço virtual do programa Solidworks, tirando assim o máximo partido do seu sistema de assembly's. Esta é uma forma eficaz e económica de se poder testar um projecto muito antes deste ter um prototipo físico, optimizando assim todo o processo de desenvolvimento e criação de novos produtos.





**Observações:**

Este trabalho foi feito em grupo, tendo participado nele Pedro Almeida e Tiago Cesar. Todos os renders apresentados são exclusivamente da minha autoria.



**UrbanGrow**  
O site UrbanGrow é uma loja online completamente funcional com cerca de 1000 produtos. Es...



**Video University Challenge**  
A XM apresenta um vídeo criado para a empresa E2T. Este vídeo é o report do evento Univ...



**Site GoingOnline**  
A XM apresenta mais um site desenvolvido em maio de 2009 com um design personalizado e for...



**Site Toranja**  
A XM apresenta mais um site desenvolvido pela nossa equipa. desta vez foi nos pedido a ins...





**Site E2T Lda**  
A XM como apolo oficial da XLPARTY apresenta mais um site feito para a empresa E2Tech Lda...



**Site University Challenge**  
A XM apresenta mais um site construído sob a plataforma Joomla 1.5, um site simples e din...

Cliente: Xispes-Media  
Url: [media.xispes.com](http://media.xispes.com)

Ferramentas:  

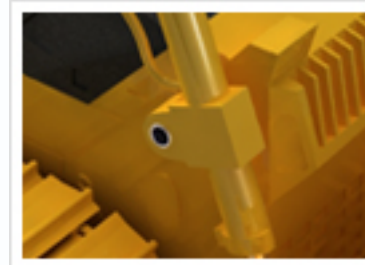
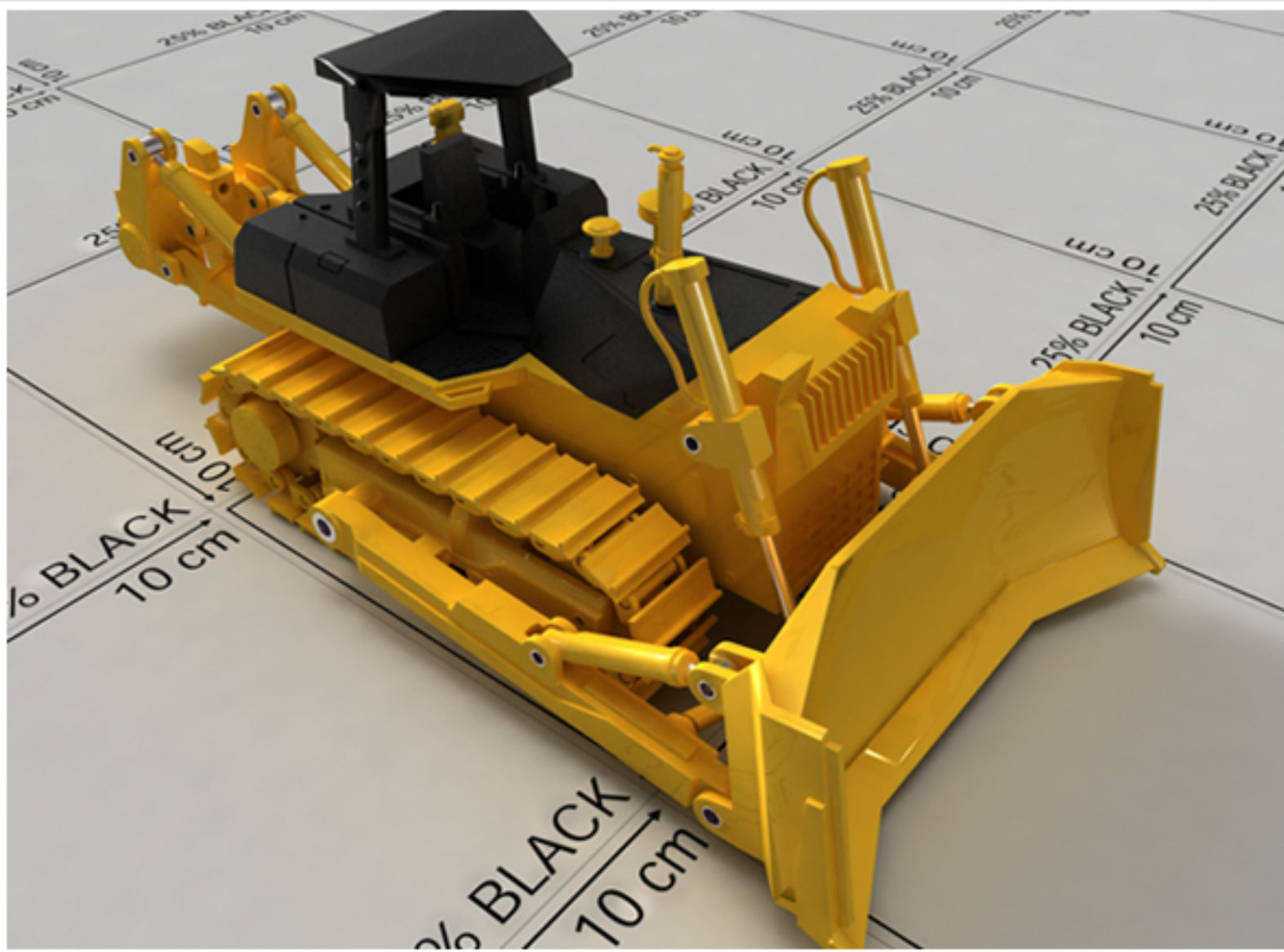



Cliente: Bruno Dias

Ferramentas:

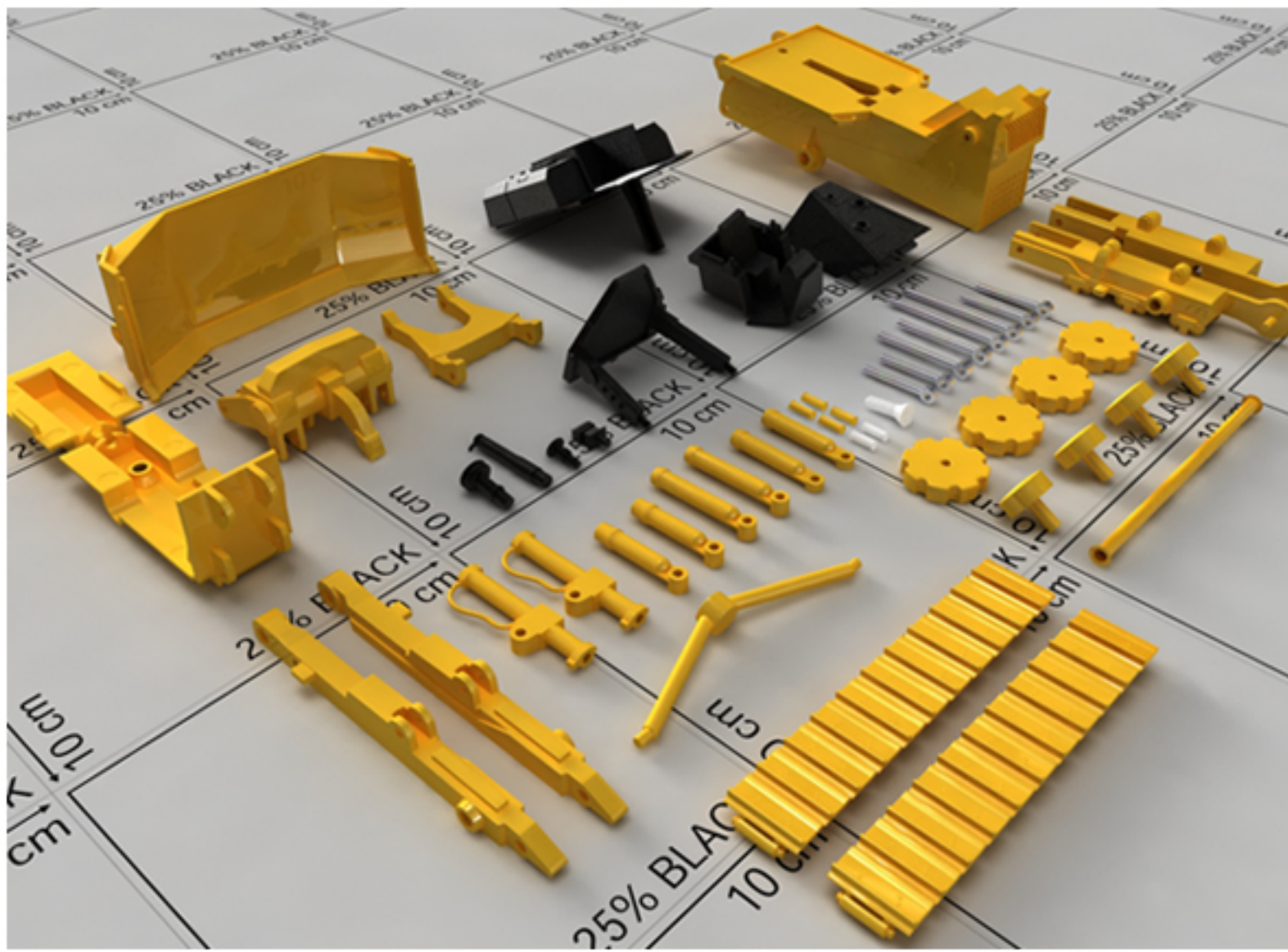



Cliente: Bruno Dias

Ferramentas:



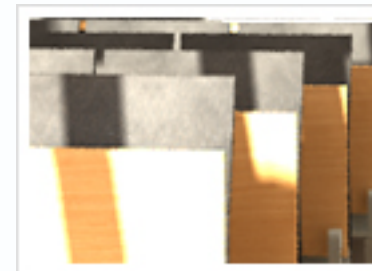

Cliente: Rui Nunes

Url: [www.youtube.com/xispesmedia](http://www.youtube.com/xispesmedia)

Ferramentas:



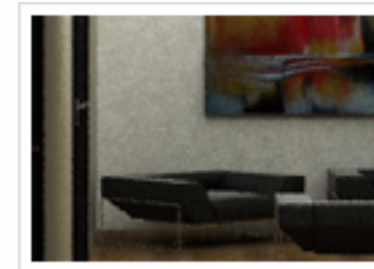

Cliente: Rui Nunes

Url: [www.youtube.com/xispesmedia](http://www.youtube.com/xispesmedia)

Ferramentas:



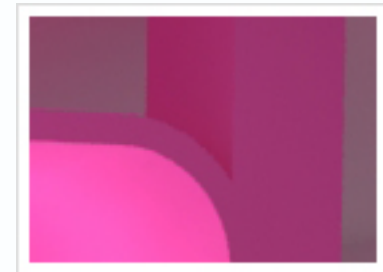
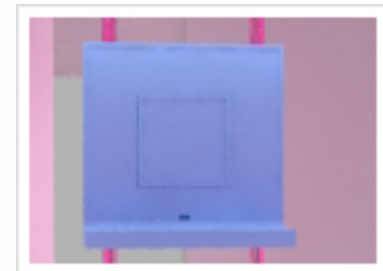

Cliente: Oficina do Design

Implementação: Terra do Móvel de Fátima

Ferramentas:



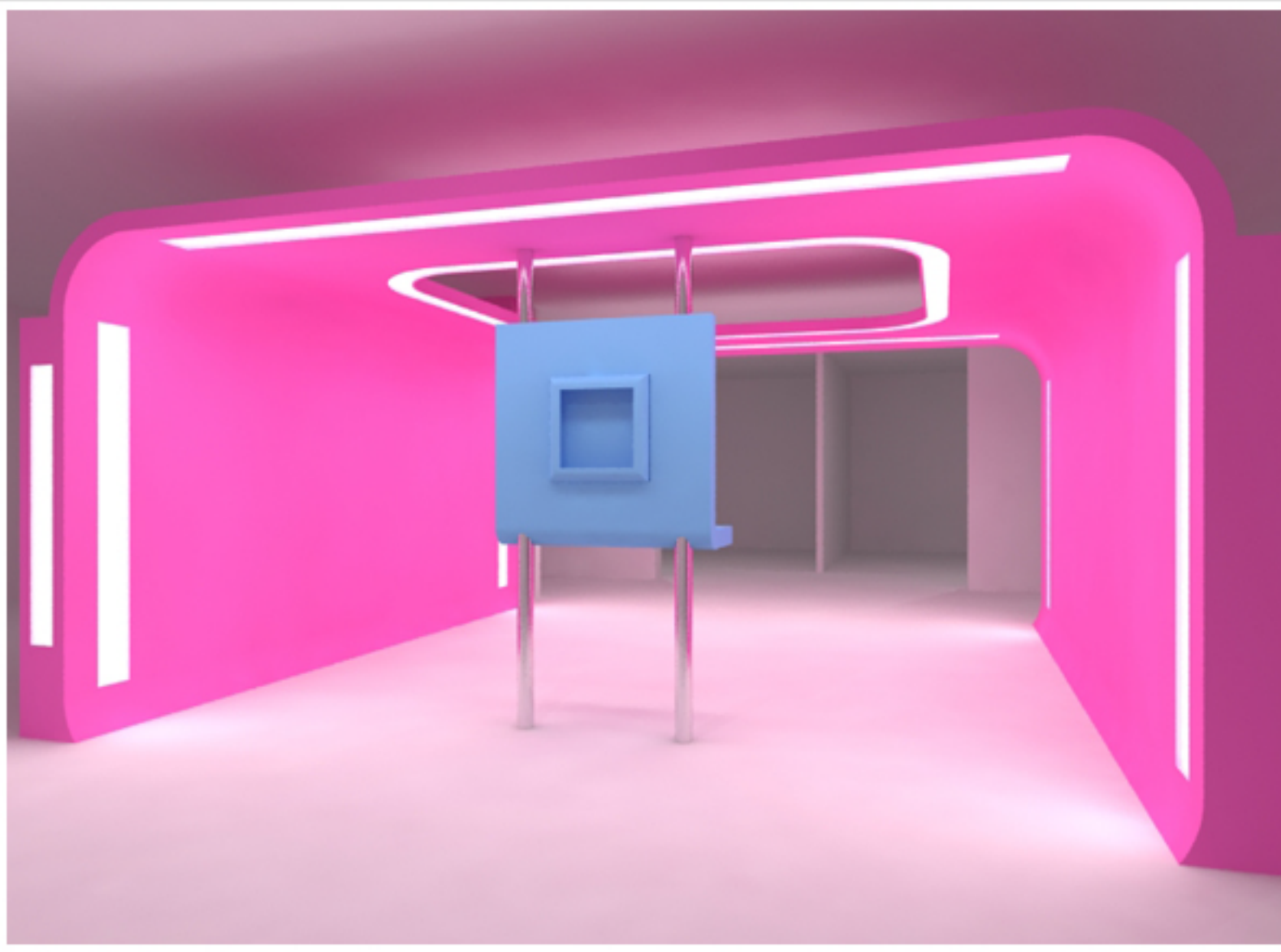

Cliente: Oficina do Design

Implementação: Terra do Móvel de Fátima

Ferramentas:



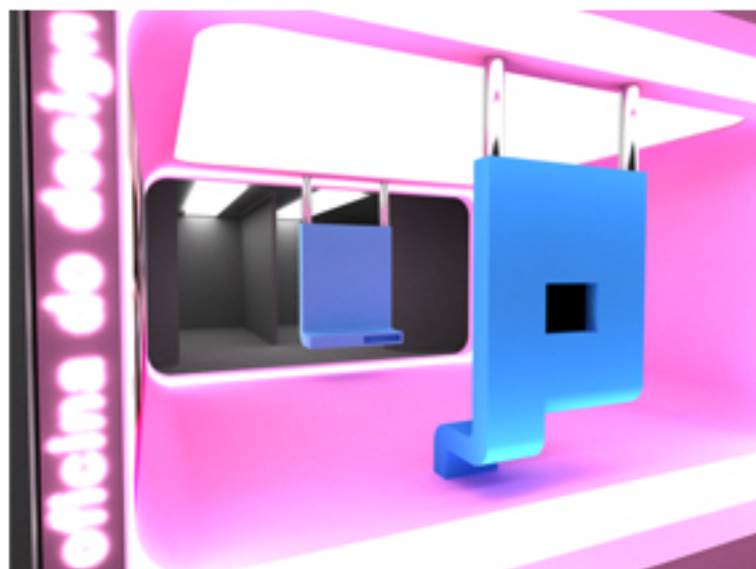
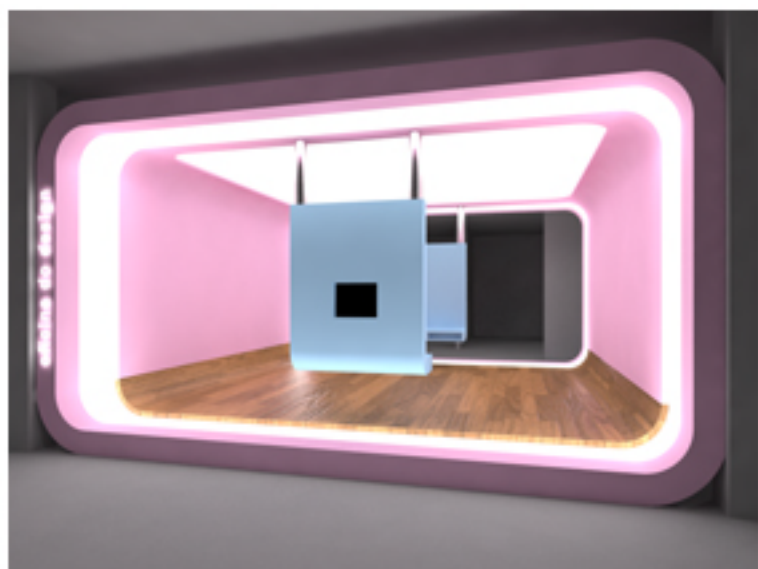
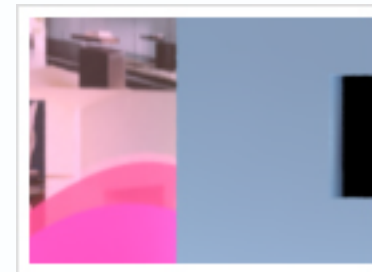
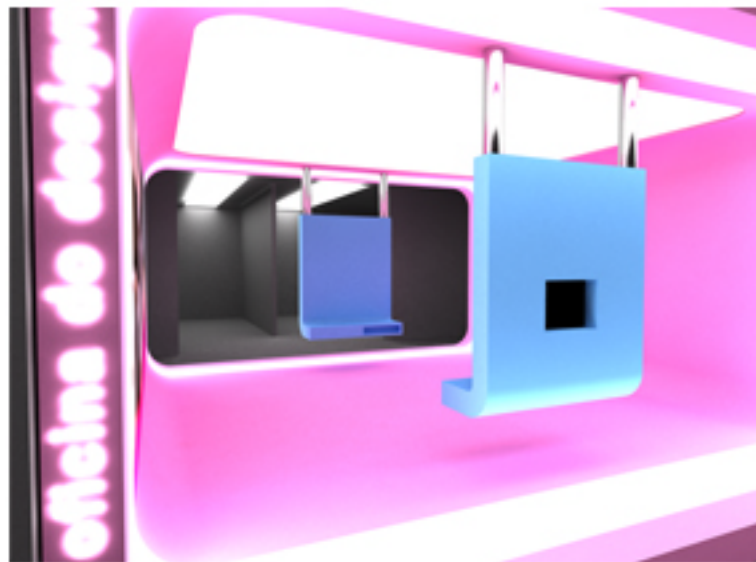
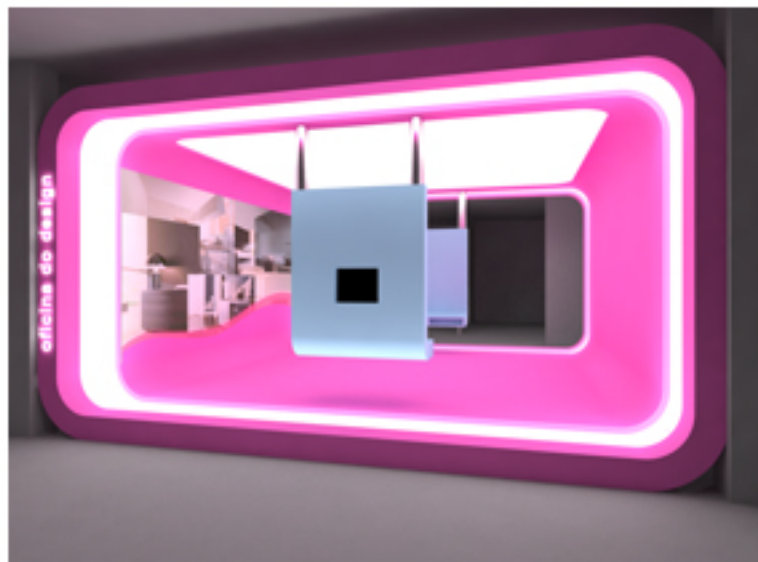

Cliente: Oficina do Design

Implementação: Terra do Móvel de Fátima

Ferramentas:





Cliente: ESAD cr.

Descrição: Trabalho Curricular

Ferramentas:





Cliente: ESAD cr.  
Descrição: Trabalho Curricular

Ferramentas:



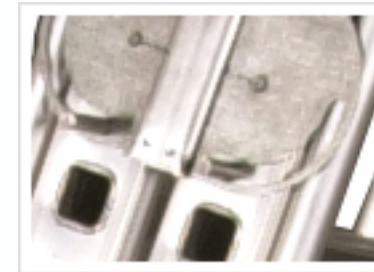

Cliente: ESAD cr.  
Descrição: Trabalho Curricular

Ferramentas:



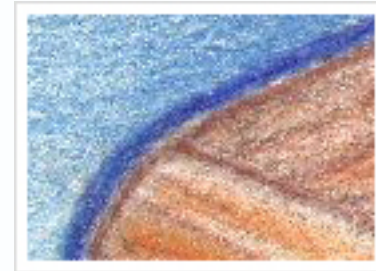
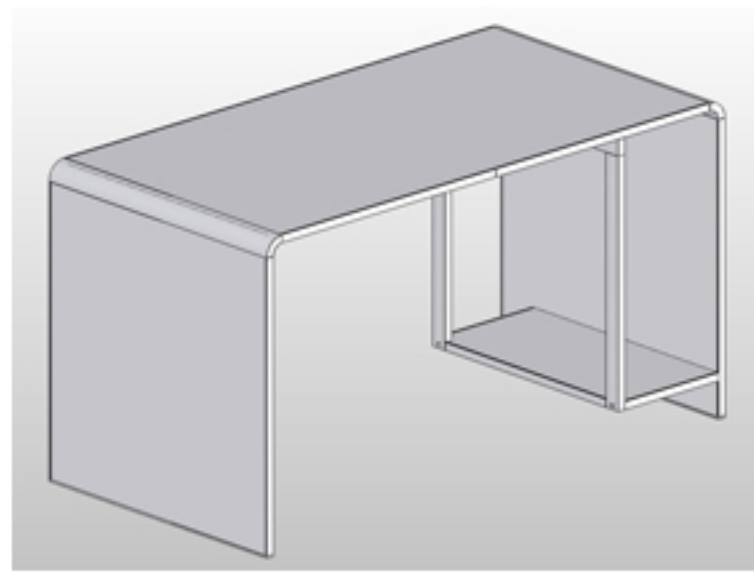
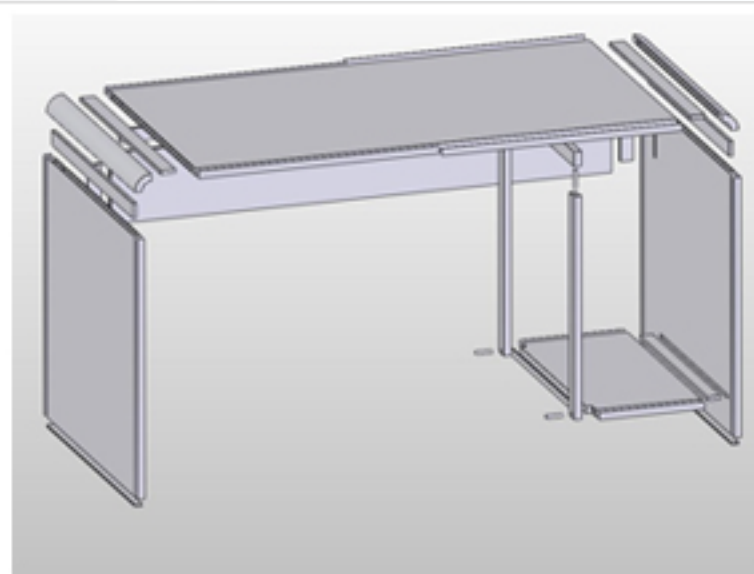
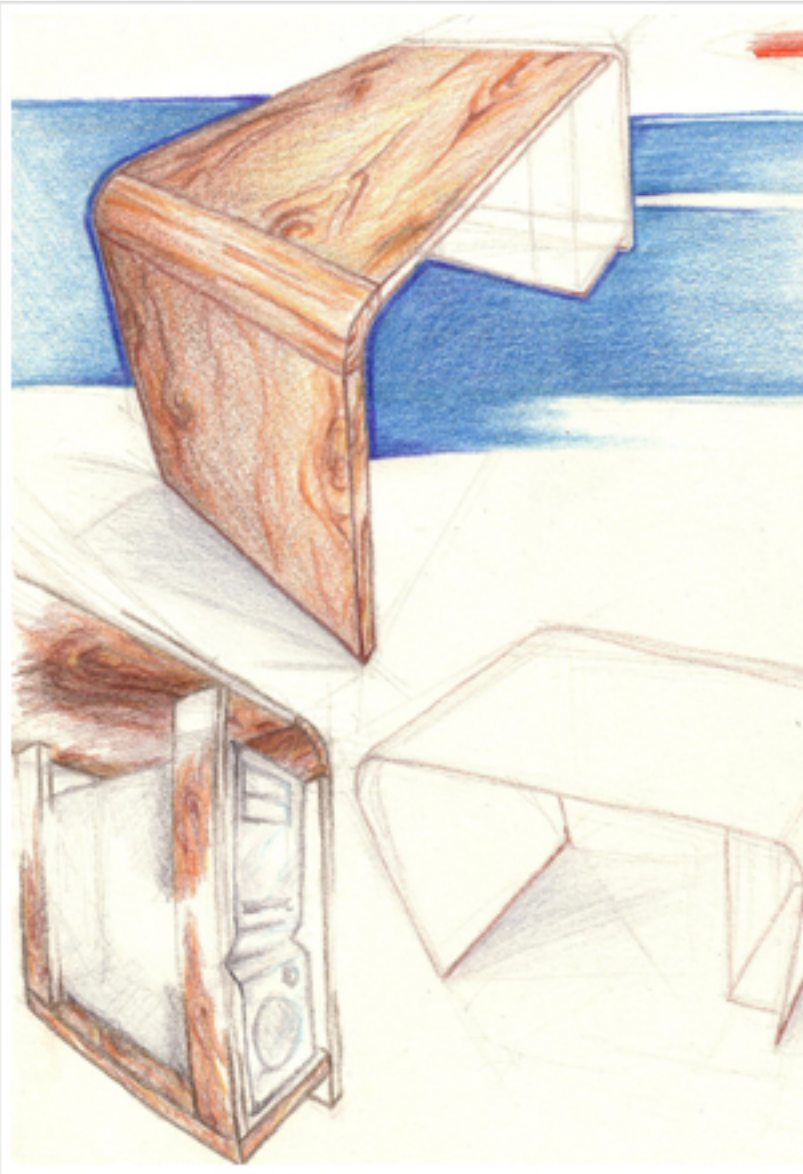

Cliente: ESAD cr.  
Descrição: Trabalho Curricular

Ferramentas:



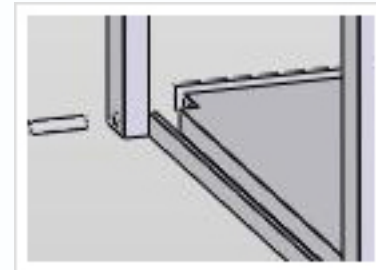
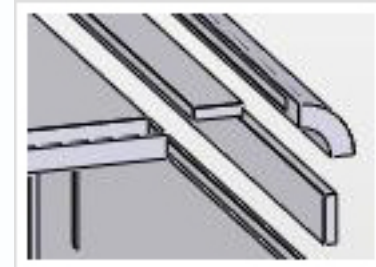
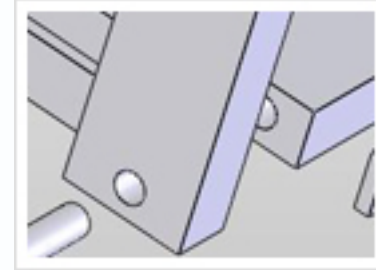

Cliente: ESAD cr.  
Descrição: Trabalho Curricular

Ferramentas:



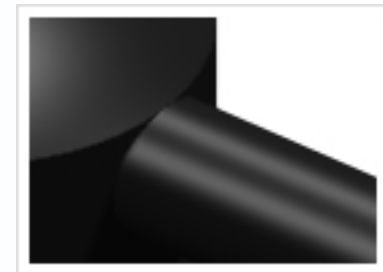
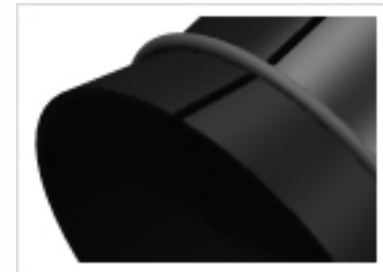

Cliente: ESAD cr.

Descrição: Trabalho Curricular

Ferramentas:



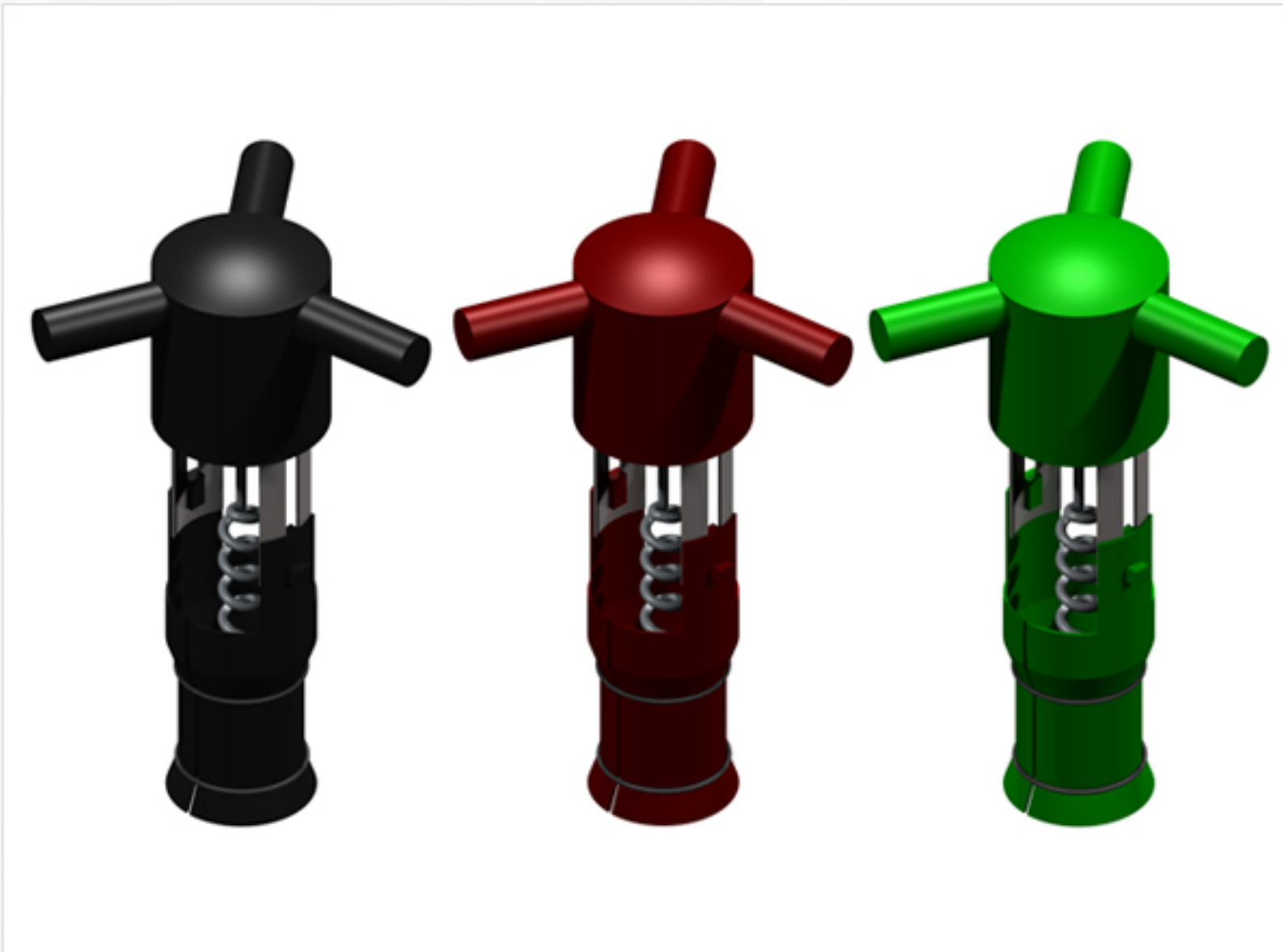

Cliente: ESAD cr.

Descrição: Trabalho Curricular

Ferramentas:

